

A

A

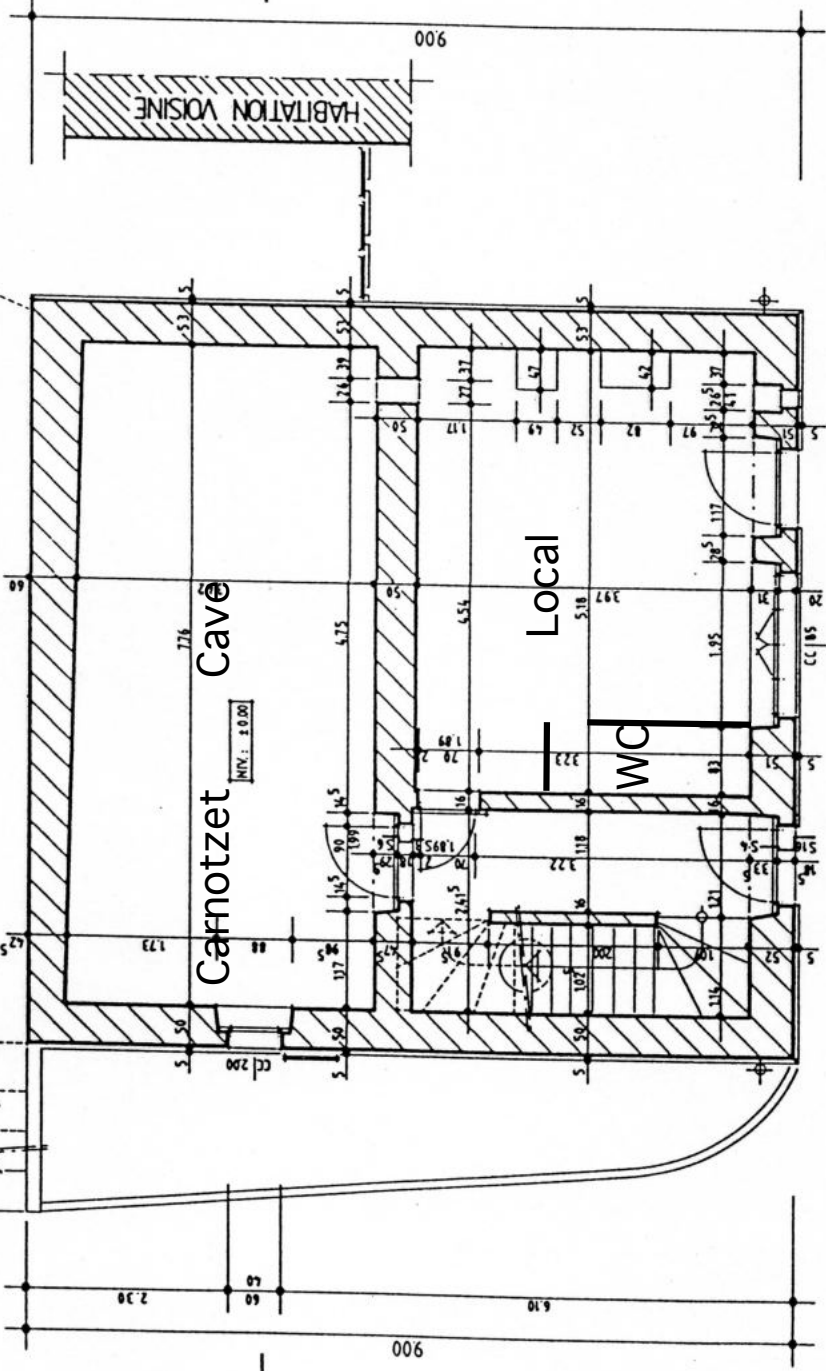

8.79

900

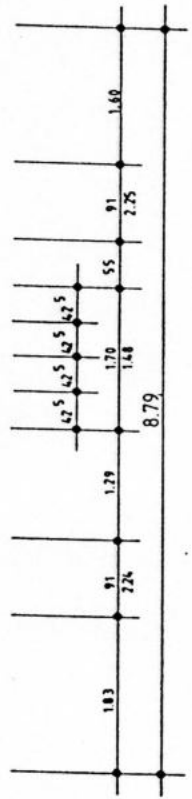

SOUS-SOL

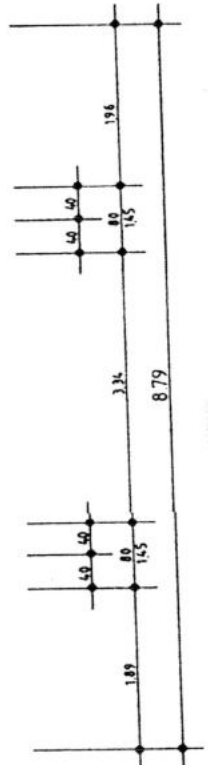
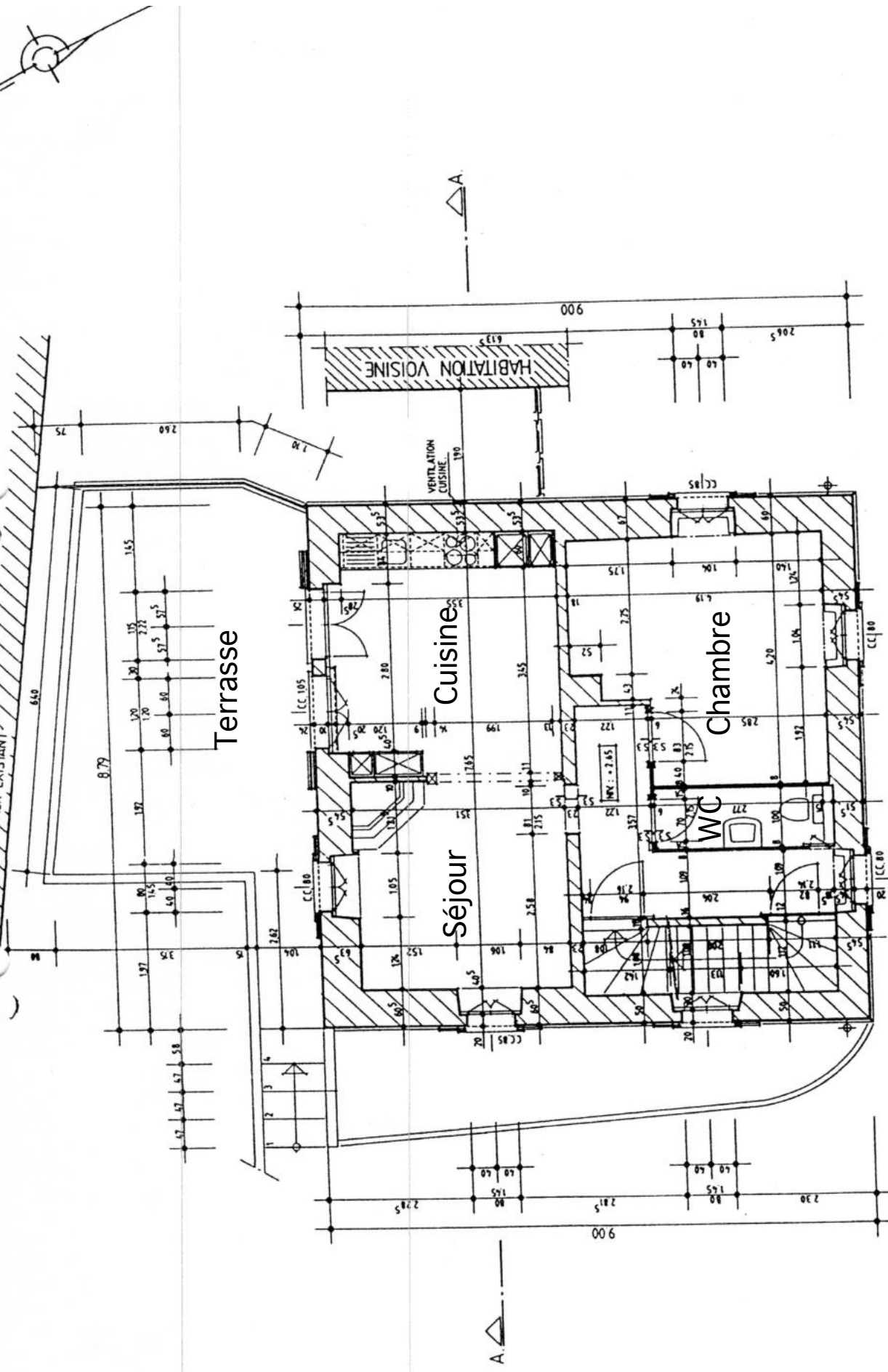

REZ-DE-CHAUSSEE

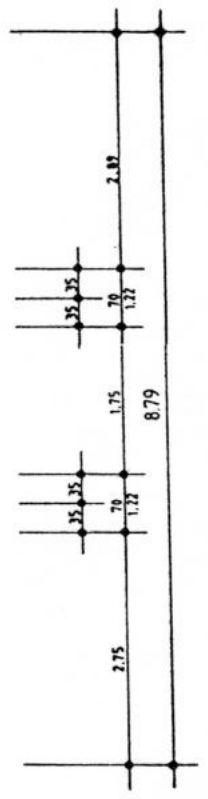
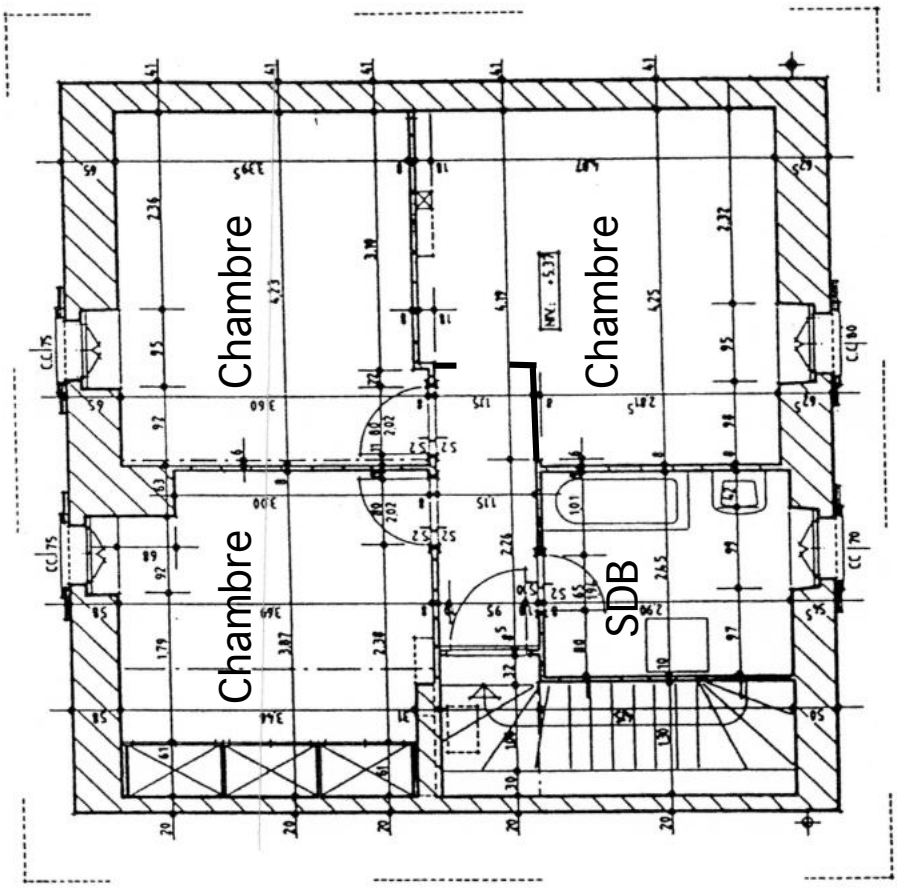
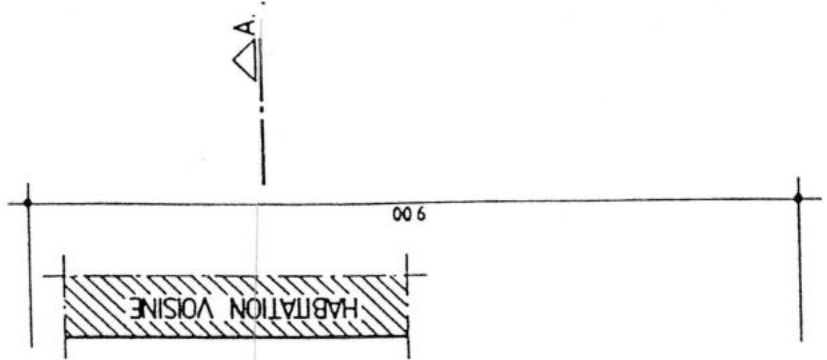
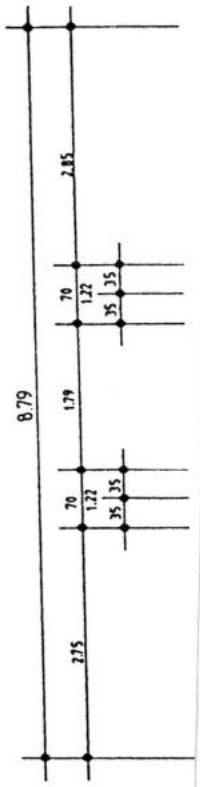
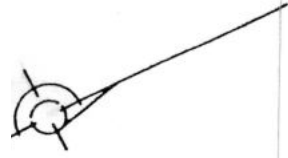

COMBLES